

# QAT-R-DM – (M or H) ELECTRONIC TIME SWITCH

## Installation and programming guidance

**GENERAL:** The programmable time switch can be used to automatically control pool pumps, lights, geysers. etc.

### Important Notes:

1. The time switch has a backup power feature which requires 12 hours to fully charge. (A fully charged time switch will retain its program and time for up to 24 hours, in the case of a power failure).
2. Pushing any button during a power failure will reduce the backup power period.
3. CBI advises that the time switch be installed by a suitably qualified person.

### ISOLATE POWER BEFORE INSTALLATION

- Install the time switch on either mini rail or din rail with the clock screen up-right.
- Wire the time switch according to **Figure 1** or **Figure 2**.

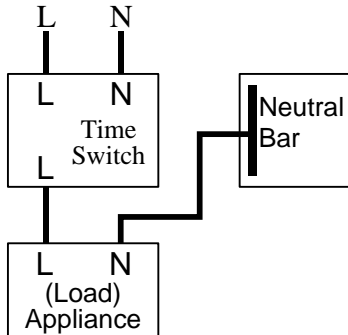

Figure 1: DB wiring

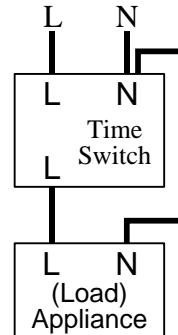

Figure 2: Stand alone wiring

**WARNING:** Do not connect more than 21A resistive or 10A inductive loads to the time switch.

For loads larger than 21A resistive or 10A inductive, connect a suitable contactor to the time switch output. Refer to **Figure 3** for connections.

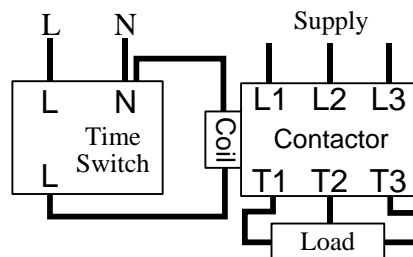

Figure 3: Wiring a contactor for loads greater than 21A resistive or 10A inductive.

### TECHNICAL DATA

PRODUCT SPECIFICATION	
Supply Voltage	230 VRMS 50 Hz
Resistive load (Geysers, under floor heating, lights)	Maximum 21 A
Inductive load (Pool pump, air conditioners)	Maximum 10 A
Degree of Ingress Protection	IP41(Not waterproofed)
Endurance	25 000 (minimum) Operations at maximum load
Operating Temperature	-20 °C to +55 °C
Reserve full charging time	12 hours
Single segment period	30 minutes
Maximum period for all segments	48 x 30 minute segments
Clock accuracy	2 to 4 minutes per month

BOM:3990A640

# PROGRAMMING

When the timer is powered up screen 1 (main screen) will appear.

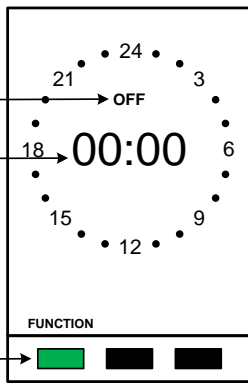
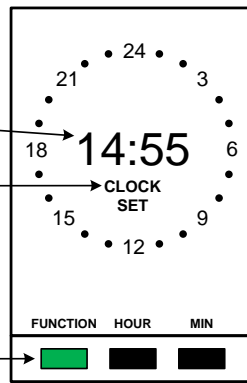
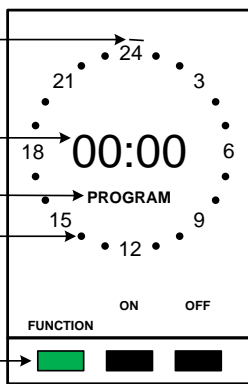
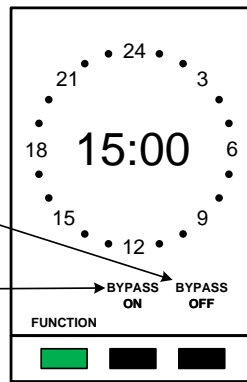
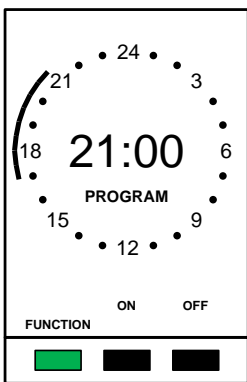
<p><b>SCREEN 1: ACTUAL TIME INDICATOR</b></p>  <p>OFF indicator for the timer switch → OFF</p> <p>Actual time → 00:00</p> <p>FUNCTION</p> <p>Green function button → [Green] [Black] [Black]</p> <p><b>PRESS</b> – Green FUNCTION button once to move to screen 2</p>	<p><b>SCREEN 2: SET ACTUAL TIME</b></p>  <p>Actual time → 14:55</p> <p>Screen indicator → CLOCK SET</p> <p>FUNCTION HOUR MIN</p> <p>Green function button → [Green] [Black] [Black]</p> <p><b>PRESS</b> – HOUR and MIN button to set actual time  <b>PRESS</b> – Green FUNCTION button once to move to screen 3</p>
<p><b>SCREEN 3: PROGRAM TIMER ON / OFF</b></p>  <p>Flashing segment → 24</p> <p>Flashing segment time → 00:00</p> <p>Screen indicator → PROGRAM</p> <p>Hourly increments on the clock face → 12</p> <p>FUNCTION ON OFF</p> <p>Green function button → [Green] [Black] [Black]</p> <p><b>PRESS</b> – OFF button to get to start program time (load – OFF)  <b>PRESS</b> – ON button repeatedly to set the program “on” duration (Load – ON)</p>	<p><b>SCREEN 4: BYPASS ON OR OFF</b></p> <p>The timer program is bypassed during this screen</p>  <p><b>PRESS</b> “BYPASS-OFF” button the timer operates according to the set program. The BYPASS-OFF flashes on the display.</p> <p><b>PRESS</b> “BYPASS-ON” button to switch the load on permanently. The BYPASS ON flashes on the display.</p> <p>FUNCTION BYPASS ON BYPASS OFF</p> <p>Green function button → [Green] [Black] [Black]</p> <p><b>PRESS</b> – Green FUNCTION button to move to screen 1</p>
<p><b>EXAMPLE: FOR AN APPLIANCE TO BE ON BETWEEN 17:00 AND 21:00</b></p> <p><b>PRESS</b> – OFF button until the program time indicate 17:00</p> <p><b>PRESS</b> – ON button repeatedly until the program time indicates 21:00</p> <p><b>PRESS</b> – FUNCTION button once to move to screen 4</p> <p>Segment display of the programmed time duration → 21:00</p>  <p>FUNCTION ON OFF</p> <p>[Green] [Black] [Black]</p>	

## Additional Notes:

- The timer goes through a self-test at start up, wait for the timer to finish before entering any data.
- The program cycle repeats every day.
- If no button is pressed, after 1 minute the timer will revert to screen 1.
- If desired, more than one Load-ON period can be programmed, e.g. Appliance ON between 04:00 - 07:00 and 13:00 - 16:00.

BOM: 3990A640